

---

Residential  
closures

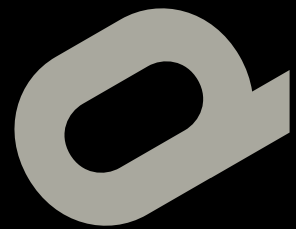

apostolidaniele

# Residential closures/

Residential closures combine aesthetics and functionality using the minimum amount of space. Performance is implemented by a high thermal insulation and a high safety degree.

**Customised design** / unique aesthetics born from your creativity, distinctive character for those who love quality and attention to details.



---

Large **98** /  
Medium **100** /  
Small **102** /  
Box **104** /  
Lateral **106** /  
Air **108** /  
Window **110** /  
Wicket pass door **112** /

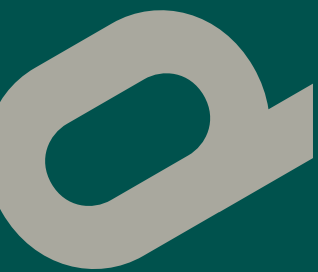

## Mechanical set-up/

### RSE/

The best solution for sectional doors with maximum dimensions up to width 3500 mm and height 2055 mm, equipped with traction springs that make the lifting.

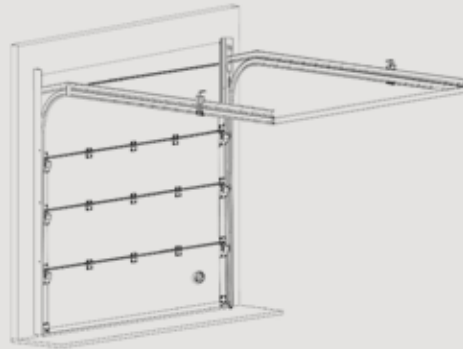

The standard version of the residential mechanics is supplied with double track and traction springs placed vertically (security is guaranteed by a double handling cable and by a system with concentric springs). The required lintel is 150 mm and the shoulders 100 mm.

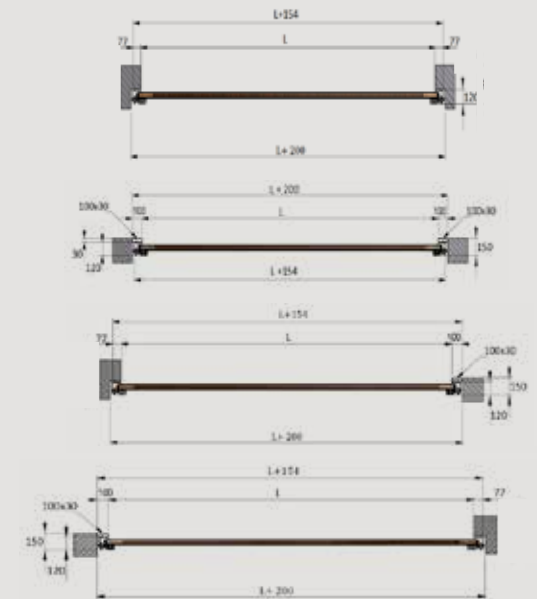

### RSC/

The best solution for all sizes sectional doors or for doors equipped with accessories such as wicket pass door or structural reinforcements for doors with big dimensions.

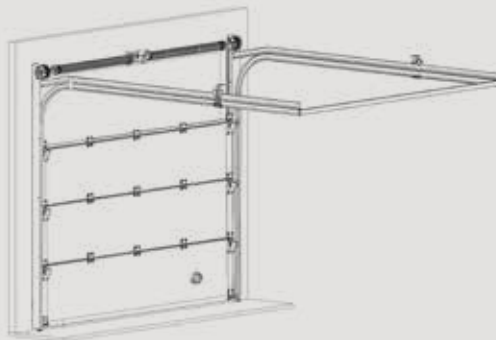



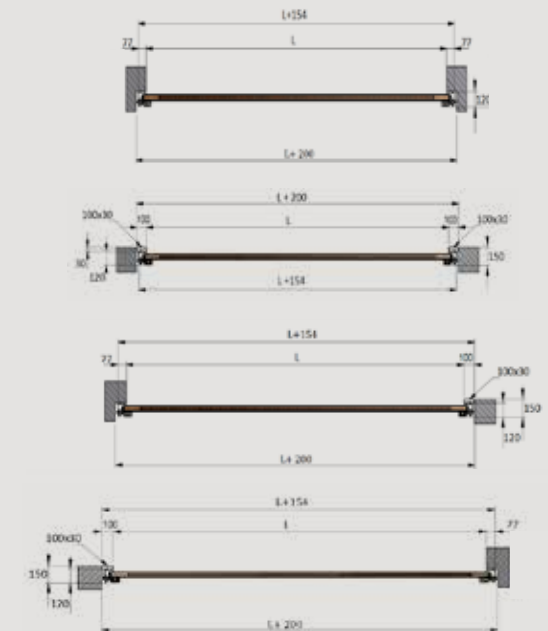

The standard version of the residential mechanics is supplied with superior double track and frontal torsion springs. The required lintel is 150 mm and the shoulders 100 mm. on demand we can supply solutions with posterior springs or slidings for sloped ceiling or with raised lintel 250 mm.

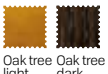

# Large

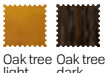
Large sectional garage doors are characterised by an essential aesthetic that could be conformed to the most modern contexts.

specification/	opening systems/		optional/
<b>Application</b> inside/outside	manual motorised		opening selector remote control motor unlock flashing photocell
<b>L Pillars</b> in press-bending galvanised plate			
<b>Covering</b> panel In press-bending galvanised plate, filled in with polyurethane foam and RAL painted or imitation-wood			
<b>Panel</b> without slats			<input type="checkbox"/>
<b>Surface</b> wood embossed wood effect or smooth			
<b>RAL variation</b> on demand			
mechanic/	finishing/		
	wood embossed/	wood effect/	smooth/
<b>RSC</b>	 RAL 9010 RAL 6009 RAL 8014	 Oak tree light Oak tree dark	 RAL 1015 RAL 9010 RAL 9006 RAL 7016 RAL 9016 Corten
<b>RSE</b>	 RAL 9010 RAL 6009 RAL 8014	 Oak tree light Oak tree dark	 RAL 1015 RAL 9010 RAL 9006 RAL 7016 RAL 9016 Corten























# Medium

Medium sectional garage doors are characterised by a simple aesthetic given by slats modularity.

specification/	opening systems/	optional/
<p><b>Application</b> inside/outside</p> <hr/> <p><b>L Pillars</b> in press-bending galvanised plate</p> <hr/> <p><b>Covering</b> panel In press-bending galvanised plate, filled in with polyurethane foam and RAL painted or imitation-wood</p> <hr/> <p><b>Panel</b> 25 cm slat </p> <hr/> <p><b>Surface</b> wood embossed wood effect or smooth</p> <hr/> <p><b>RAL variation</b> on demand</p>	<p>manual motorised</p>	<p>opening selector remote control motor unlock flashing photo cell</p>













mechanic/	finishing/		
	wood embosse/	wood effect/	smooth/
<b>RSC</b>	 RAL 9010  RAL 6005  RAL 8014	 Bleached durmast  Oak tree light  Oak tree dark	 RAL 9010  RAL 7016  RAL 9006
<b>RSE</b>	 RAL 9010  RAL 6005  RAL 8014	 Bleached durmast  Oak tree light  Oak tree dark	 RAL 9010  RAL 7016  RAL 9006



# Small

Small sectional garage doors are characterised by a contemporary aesthetic thanks to the panel with 10 cm slat.

specification/	opening systems/	optional/
<b>Application</b> inside/outside	manual motorised	opening selector remote control motor unlock flashing photocell
<b>L Pillars</b> in press-bending galvanised plate		
<b>Covering</b> panel In press-bending galvanised plate, filled in with polyurethane foam and RAL painted or imitation-wood		
<b>Panel</b> 10 cm slat		
<b>Surface</b> wood embossed wood effect or smooth		
<b>RAL variation</b> on demand		



mechanic/	finishing/					
	wood embossed/	wood effect/		smooth/		
<b>RSE</b>	RAL 9010 	RAL 9006 	RAL 9002 	Oak tree light 	Oak tree dark 	RAL 9006 
<b>RSC</b>	RAL 9010 	RAL 9006 	RAL 9002 	Oak tree light 	Oak tree dark 	RAL 9006 





# Box

The sectional garage door Box lends a refined and classic image.

specification/	opening systems/	optional/
<p><b>Application</b> inside/outside</p> <hr/> <p><b>L Pillars</b> in press-bending galvanised plate</p> <hr/> <p><b>Covering</b> panel In press-bending galvanised plate, filled in with polyurethane foam and RAL painted or imitation-wood</p> <hr/> <p><b>Panel</b> with frame </p> <hr/> <p><b>Surface</b> wood embossed</p> <hr/> <p><b>RAL variation</b> on demand</p>	<p>manual motorised</p>	<p>opening selector remote control motor unlock flashing photocell</p>
mechanic/	finishing/	
	wood embossed	
<b>RSC</b>	 RAL 9010	
<b>RSE</b>	 RAL 9010	

# Lateral

The lateral sliding is ideal for contexts with absent or reduced lintel ( H 60 mm), or for situations that require to contain the overall dimensions of the passage in width ( S 40 mm / S 100 mm).

## specification/

### Vertical panel available in version

large  
medium  
small

### Surface



























wood embossed,  
wood effect or smooth

### RAL variation

on demand

## panel/

## finishing/

	wood embossed/	wood effect/	smooth/
<b>Large</b>	 RAL 9010  RAL 6009  RAL 8014	 Oak tree light  Oak tree dark	 RAL 1015  RAL 9010  RAL 9006  RAL 7016  RAL 9016  Corten
<b>Medium</b>	 RAL 9010  RAL 6005  RAL 8014	 Bleached durmast  Oak tree light  Oak tree dark	 RAL 9010  RAL 7016  RAL 9006
<b>Small</b>	 RAL 9010  RAL 9006  RAL 9002	 Oak tree light  Oak tree dark	 RAL 9006













# Air

Air sectional door maintains a perfect space ventilation, as well as an effect strongly characterizing.

specification/	opening systems/	optional/						
<p><b>Application</b> inside/outside</p> <hr/> <p><b>L Pillars</b> in press-bending galvanised plate</p> <hr/> <p><b>Covering</b> composed by aluminium frame with filling in micro-perforated galvanised plate</p> <hr/> <p><b>Frame</b> in reinforced aluminium, with panels in perforated steel</p> <hr/> <p><b>Use</b> suitable for garages and apartment buildings</p> <hr/> <p><b>Possibility of:</b></p> <ul style="list-style-type: none"> <li>· integrated wicket pass door or external lateral pedestrian door</li> <li>· intensive use</li> <li>· motorisation</li> <li>· traffic light for exits management</li> <li>· advanced security systems</li> </ul>	<p>manual motorised</p>	<p>opening selector remote control motor unlock flashing photocell</p>						
<p><b>finishing/</b></p> <table border="0"> <tr> <td>frame</td> <td>filling</td> </tr> <tr> <td></td> <td></td> </tr> <tr> <td>anodised aluminium</td> <td>RAL 9006</td> </tr> </table>	frame	filling			anodised aluminium	RAL 9006		
frame	filling							
								
anodised aluminium	RAL 9006							





# Window

The sectional window door stands out for its clean and modern design conferred by wide glass windows.

specification/	opening systems/	optional/		
<p><b>Application</b> inside/outside</p> <hr/> <p><b>L Pillars</b> in press-bending galvanised plate</p> <hr/> <p><b>Covering</b> composed by glazed aluminium frame or RAL painted with windows</p> <hr/> <p><b>Frame</b> in reinforced aluminium, with steel panels</p> <hr/> <p><b>Possibility of:</b></p> <ul style="list-style-type: none"> <li>· integrated wicket pass door or external lateral pedestrian door</li> <li>· intensive use motorisation</li> <li>· traffic light for exits management</li> <li>· advanced security systems</li> </ul>	<p>manual motorised</p>	<p>opening selector remote control motor unlock flashing photocell</p>		
<p><b>finishing/</b></p> <hr/> <table style="width: 100%; border: none;"> <tr> <td style="text-align: center; width: 50%;"> <p>frame</p>  <p>anodised aluminium</p> </td> <td style="text-align: center; width: 50%;"> <p>filling</p>  <p>RAL 9006</p> </td> </tr> </table>			<p>frame</p>  <p>anodised aluminium</p>	<p>filling</p>  <p>RAL 9006</p>
<p>frame</p>  <p>anodised aluminium</p>	<p>filling</p>  <p>RAL 9006</p>			

# Pedestrian doors/

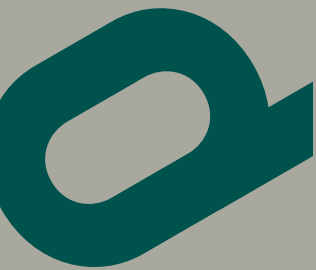

## Integrated/

Integrated pedestrian door obtained within the sectional door. Ideal for contexts in which pedestrian passages are needed.

/Available in sizes L 800 mm and L 1200 mm complete with door closer, handle or panic bar and standard lock or three-point locking mechanism. Possibility of lowered walkable threshold to facilitate the passage of vehicles on wheels.



Traditional threshold

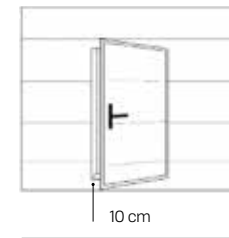

Lowered threshold

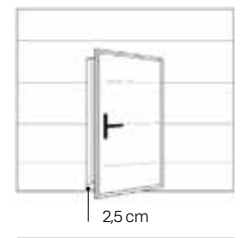

With frame Without frame



## Lateral/

Lateral pedestrian door made to measure with the same panel of the sectional door, complete with door closer, supporting structure in aluminium profiles and sealing gaskets along the whole perimeter.

/The door with double leaved is available on request, whereas the structure can be ordered with or without frame.



Follow us on  
[apostoli.it](http://apostoli.it)



**apostolidaniele**

**Registered office/**

Viale Duca degli Abruzzi 167  
25124 Brescia, Italy

**Operational headquarter/**

Via Palazzo SNC  
25010 Montirone (BS), Italy

**Tel. / Fax**

+39 **030 2170484**  
+39 **030 2170482**

**apostoli.it**  
clienti@apostoli.it